



INSTALLATION INSTRUCTIONS

SM110154

Important Instructions. Please read first.

- Please follow instructions carefully. Failure to do so will void warranty. Please ensure installation complies with local law and applicable standards.
 1. Ensure correct input voltage is connected to the luminaire.
 2. Ensure the power is disconnected before making any connections.
 3. Do not make modification or alter the luminaire without written approval from GLP.
 4. Ensure to keep luminaire in a clean area free of debris.

INSTALLATION

- **Step 1:** Find the location where the luminaire has to be installed. Install a suitable wiring from the main supply (180-250V AC, 50/60Hz) to the luminaire.
- **Step 2:** Take out the main supply from the ceiling and fix the fischers .

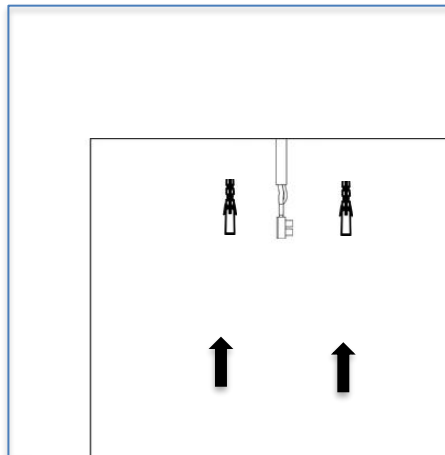
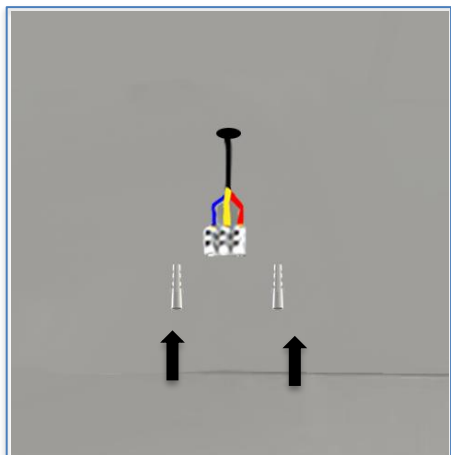

- **Step 3:** Fix the mounting bracket on the ceiling using screws.

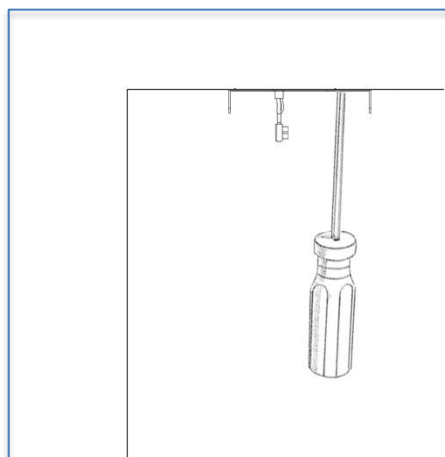

All the Installation and Maintenance must be done by Technicians and Professional Engineers



- **Step 4:** Connect the luminaire power cable to the main supply using terminal blocks or connectors. Wrap connectors or terminal blocks with electrical tape.

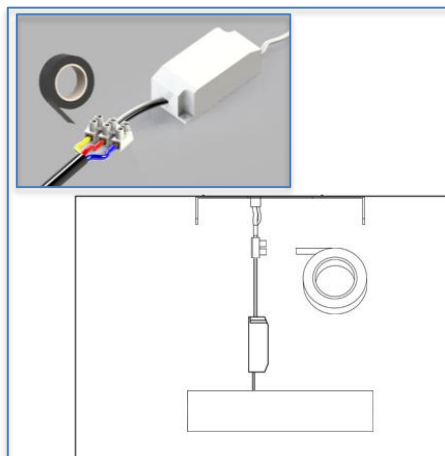
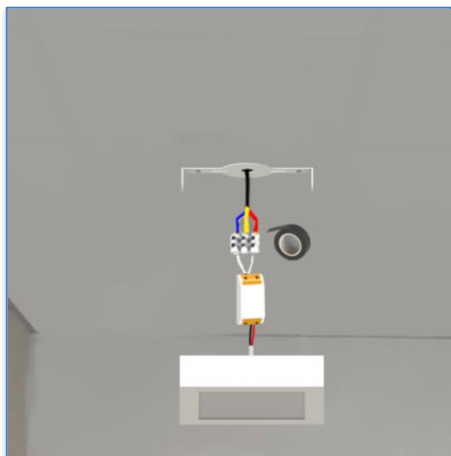

- **Step 5:** Fix the luminaire on the mounting bracket using screw driver.

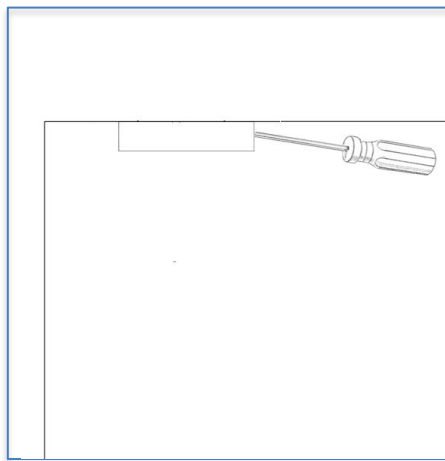
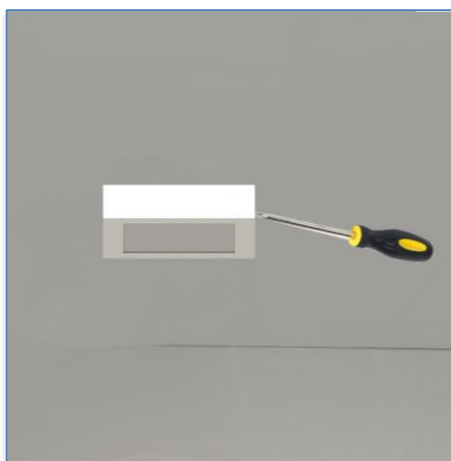

Make sure the main power is switched off during installations.

All the Installation and Maintenance must be done by Technicians and Professional Engineers