



INSTALLATION INSTRUCTION

RC330003

Important Instructions. Please read first.

- Please follow instructions carefully. Failure to do so will void the warranty. Please ensure installation complies with local law and applicable standards.
 1. Only use a GLP power supply unit.
 2. Ensure correct input voltage is supplied to the luminaire.
 3. Ensure the power is disconnected before making any connections.
 4. Do not make modification nor alter the luminaire without written approval from GLP.
 5. Ensure to keep luminaire in a clean area free of debris.

INSTALLATION

- **Step 1:** Find a location where the luminaire has to be installed. Install a suitable wiring from the power supply (12V AC/DC) to the luminaire.
- **Step 2:** Fix the luminaire onto a hard surface using appropriate stainless steel screws.

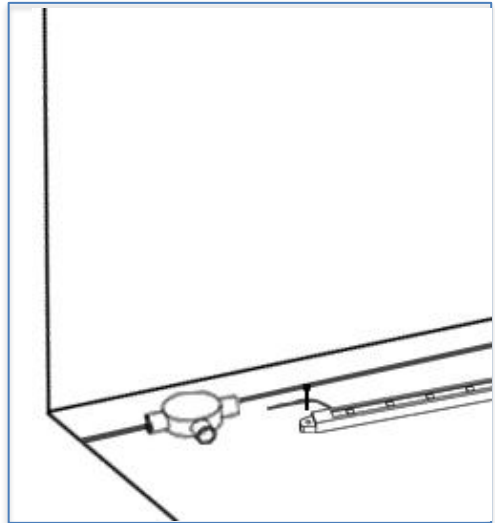
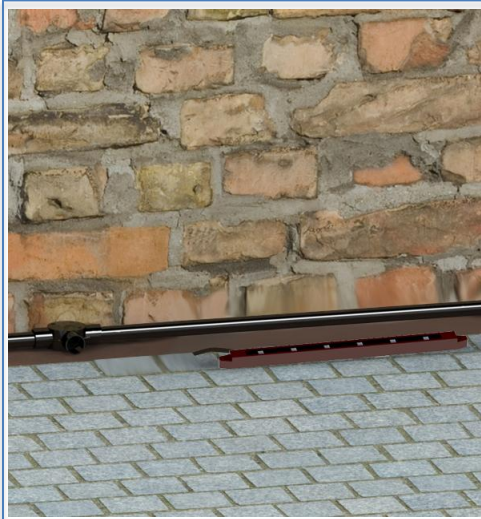

- **Step 3:** Connect the luminaire input cable to the main power supply (12V AC/DC) cable. Ensure the junction box is installed within 2 meters from the luminaire. (Do not cut the main power supply cable, just remove insulation, twist the luminaire input cable around the main cable). Solder the connections, wrap the connection with 3M waterproof tape & electrical tape and keep all the connections inside the junction box.



DO NOT
CUT MAIN
CABLE

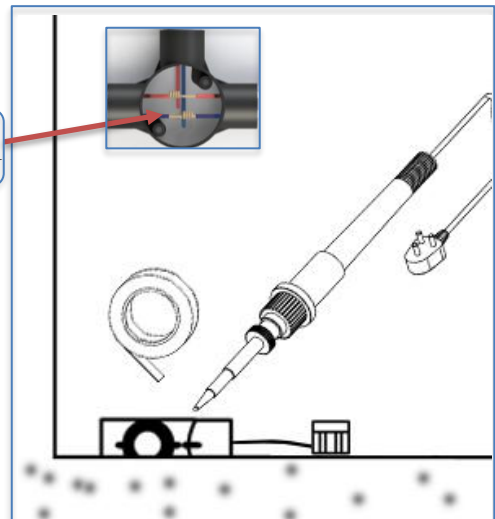



- **Step 4:** Ensure to keep luminaire in a clean area free of debris.

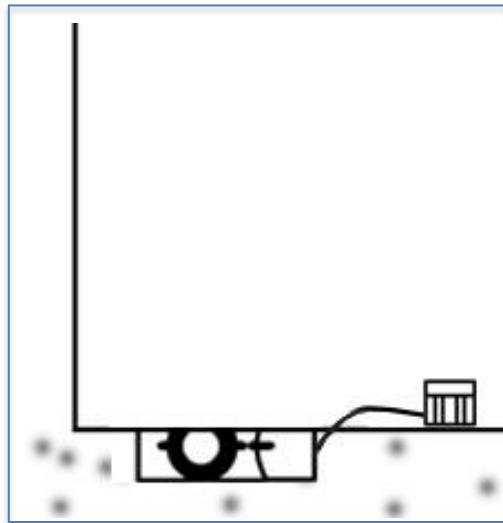

No. of fixtures	Wattage	Total Wattage	Wire size
20 - 10 - 7	4.5W - 8.5W - 12W	90W	2.5mm ²
26 - 14 - 10	4.5W - 8.5W - 12W	120W	4mm ²
40 - 21 - 15	4.5W - 8.5W - 12W	180W	6mm ²
50 - 28 - 20	4.5W - 8.5W - 12W	240W	10mm ²