

INSTALLATION INSTRUCTIONS

DW220266

Important Instructions. Please read first.

- Please follow instructions carefully. Failure to do so will void warranty. Please ensure installation complies with local law and applicable standards.
 1. Only use a GLP power supply unit.
 2. Ensure correct input voltage is connected to the luminaire.
 3. Ensure the power is disconnected before making any connections.
 4. Do not make modification or alter the luminaire without written approval of GLP.
 5. Ensure to keep luminaire in a clean area free of debris.



INSTALLATION

- **Step 1:** Find the location where the luminaire has to be installed. Install a suitable wiring from the power supply (12VAC) to the luminaire.
- **Step 2:** Dig the mounting hole 20cm or deeper before installing the sleeve. Install the sleeve in the hard surface.

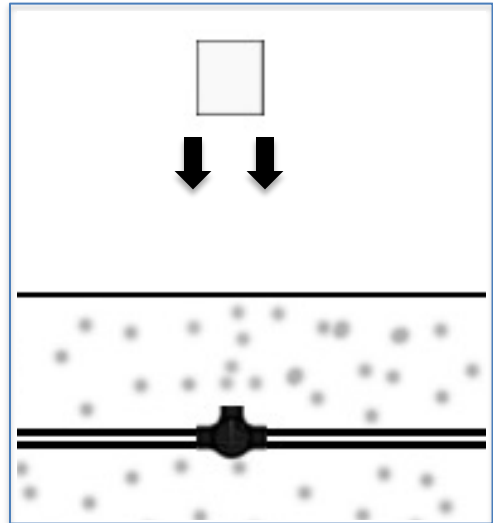
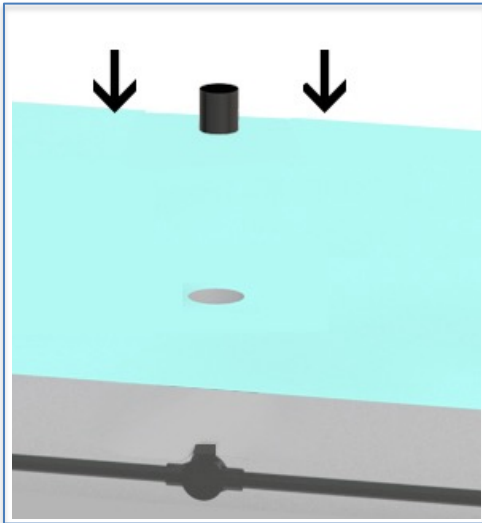

- **Step 3:** Depending on tile thickness, raise the recessed sleeve by 1-2cm above the surface. Connect the luminaire input cable to the power supply cable.

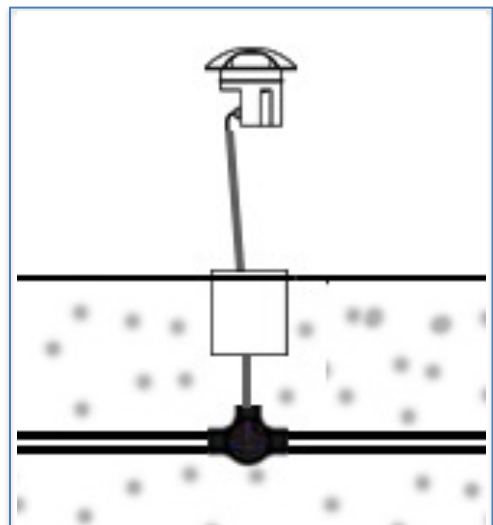
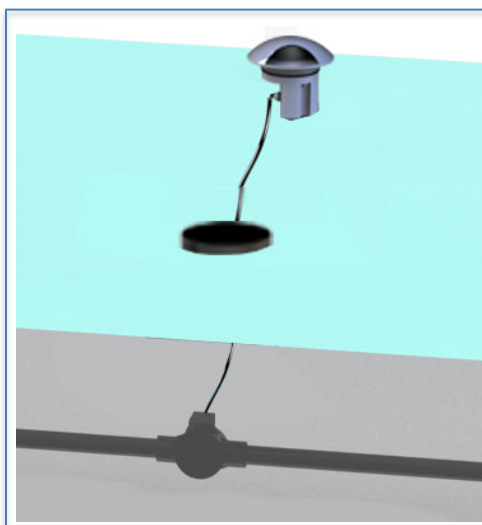

- **Step 4:** Ensure the junction box is installed within one meter from the luminaire. (Do not cut the main power supply cable, just remove insulation, twist the luminaire input cable around the main cable). Solder the connections, wrap the connection with 3M waterproof tape & electrical tape and keep all the connections inside the junction box as illustrated.

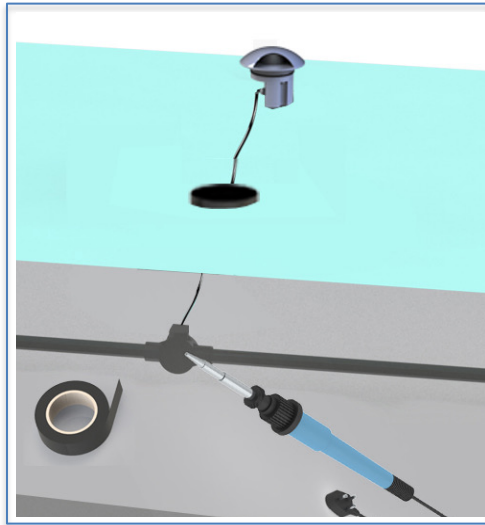

DO NOT CUT MAIN CABLE

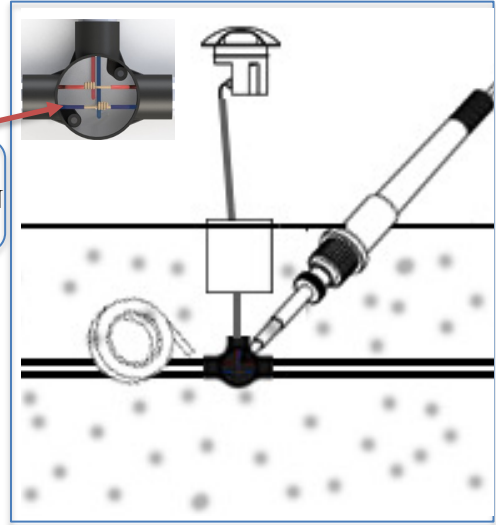

- **Step 5:** Fix the luminaire to the sleeve by press as illustrated.

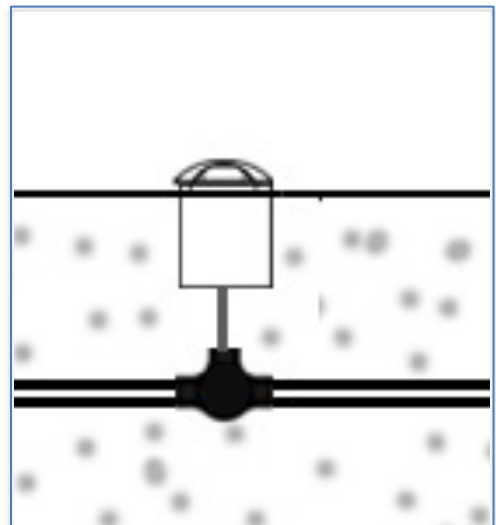
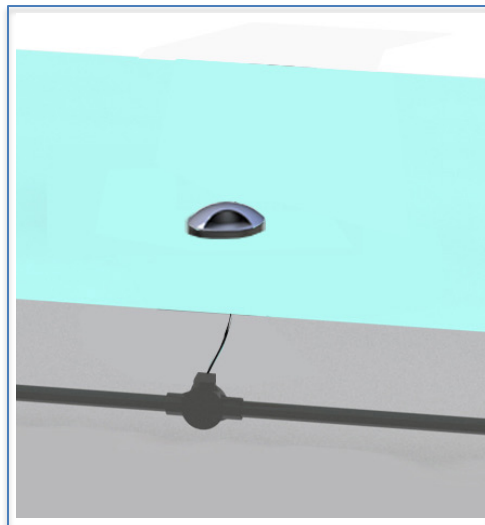

No. of fixtures	Wattage	Total Wattage	Wire size
40 - 20	1.2W - 4W	90W	2.5mm ²
55 - 26	1.2W - 4W	120W	4mm ²
85 - 40	1.2W - 4W	180W	6mm ²
110 - 50	1.2W - 4W	240W	10mm ²



Make sure the main power is switched off during installation.

All the Installation and Maintenance must be done by Technicians and Professional Engineers