

Important Instructions. Please read first.

- Please follow instructions carefully. Failure to do so will void warranty. Please ensure installation complies with local law and applicable standards.
 1. Only use a GLP power supply unit.
 2. Ensure correct input voltage is connected to the luminaire.
 3. Ensure the power is disconnected before making any connections.
 4. Do not make modification or alter the luminaire without written approval of GLP.
 5. Ensure to keep luminaire in a clean area free of debris.



INSTALLATION

- **Step 1:** Find the location where the luminaire has to be installed. Install a suitable wiring from the main supply (180-250VAC, 50/60Hz) to the luminaire.
- **Step 2:** Dig the mounting hole 20cm or deeper before installing the sleeve. Install the sleeve in the hard surface.

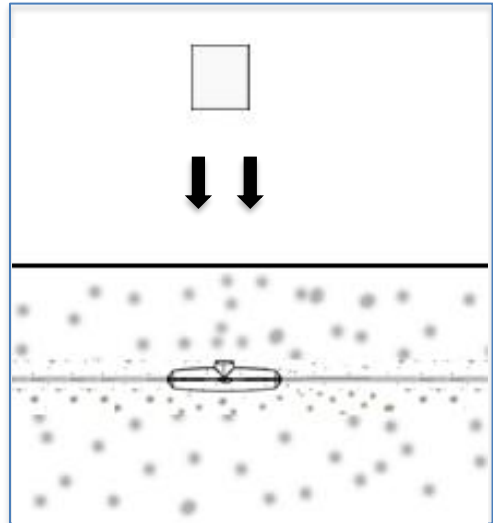
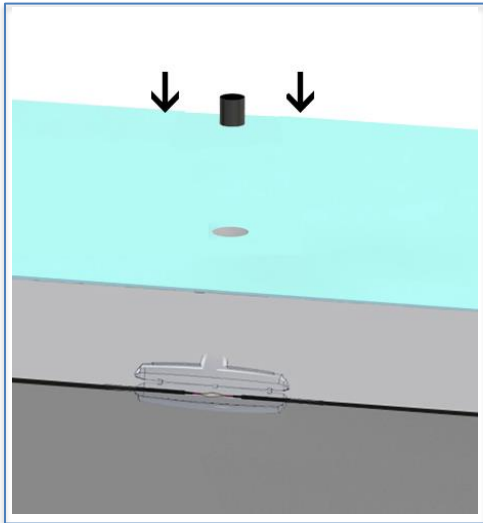

- **Step 3:** Depending on tile thickness, raise the recessed sleeve by 1-2cm above the surface. Connect the luminaire input cable to the main supply (180-250V AC, 50/60Hz) using a waterproof KIT.

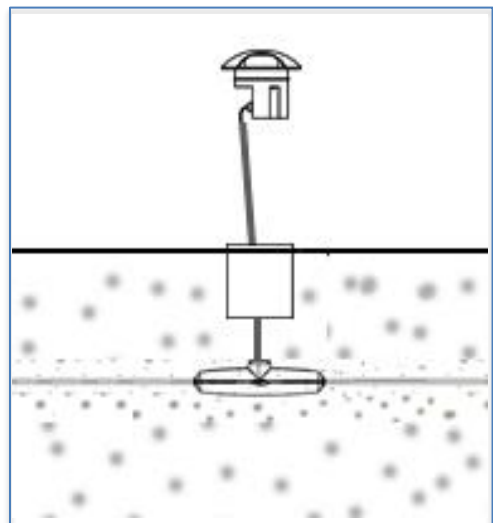
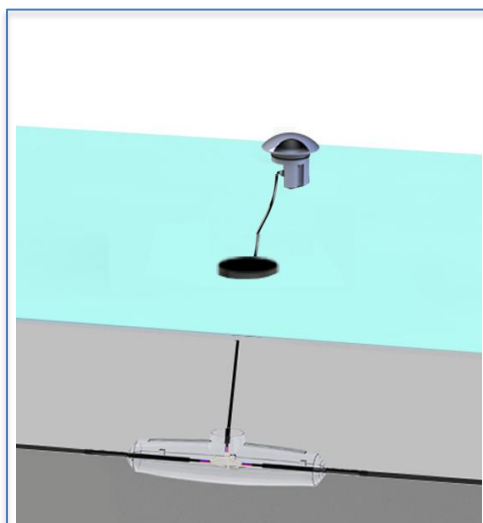

- **Step 4:** Ensure the waterproof KIT is installed with in 30cm from the luminaire. Please make sure the earth (ground) wire is reliable. Solder and Wrap the connections with 3M waterproof tape & electrical tape. Fill the M11 kit with epoxy as illustrated.

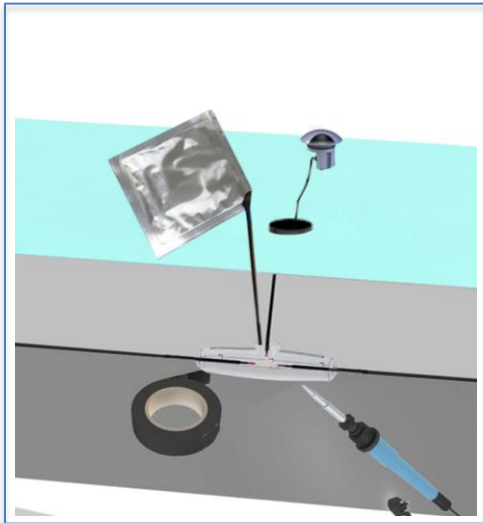

DO NOT CUT MAIN CABLE

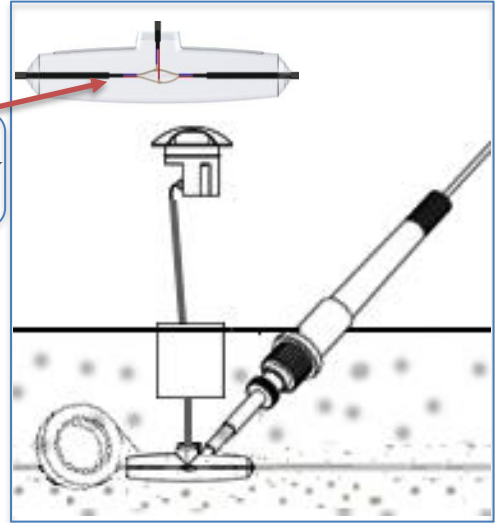

- **Step 5:** Fix the luminaire to the sleeve by press as illustrated.

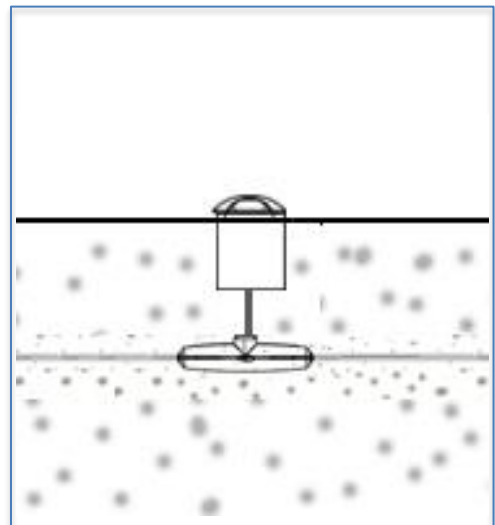
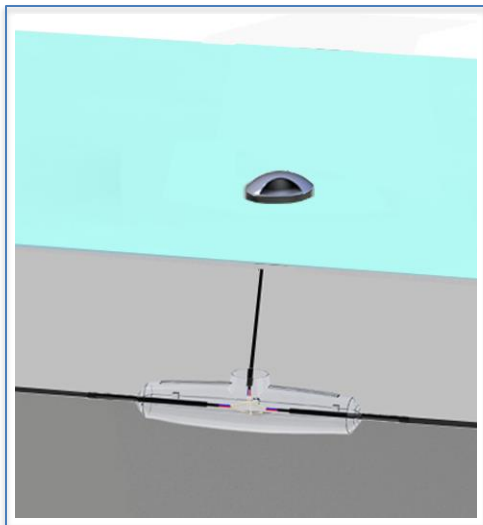

Make sure the main power is switched off during installation.

All the Installation and Maintenance must be done by Technicians and Professional Engineers

