



INSTALLATION INSTRUCTIONS

PL550046

Important Instructions. Please read first.

- Please follow instructions carefully. Failure to do so will void the warranty. Please ensure installation complies with local law and applicable standards.
 1. Only use a GLP power supply unit.
 2. Ensure correct input voltage is connected to the luminaire.
 3. Ensure the power is disconnected before making any connections.
 4. Do not make modification nor alter the luminaire without written approval from GLP.
 5. Ensure to keep luminaire in a clean area free of debris.



INSTALLATION

- **Step 1:** Run suitable wire from the main supply (180-250VAC, 50/60Hz) to the pole base. Make sure L- bolt to be installed in advance before fixing the pole. Also keep the main cable extended 1m from the base.
- **Step 2:** Place the pole light into the L-bolts and tighten it properly using the provided nuts.

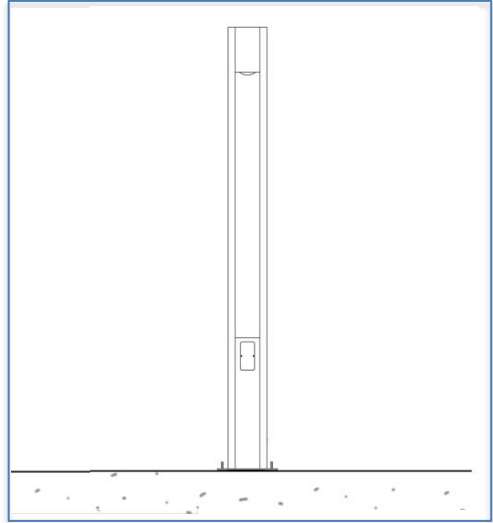
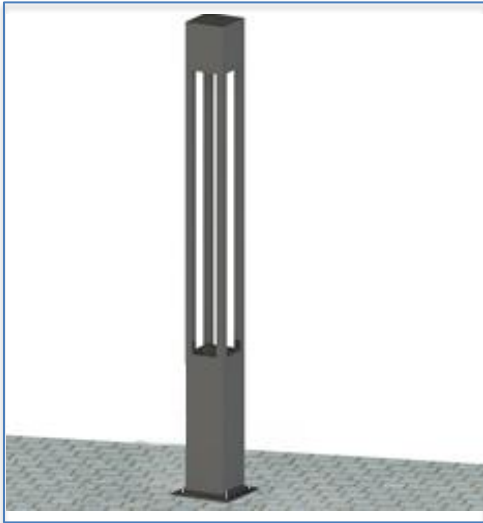

- **Step 3:** Remove the electrical compartment access cover and pull the fixture input cable and main cable out.

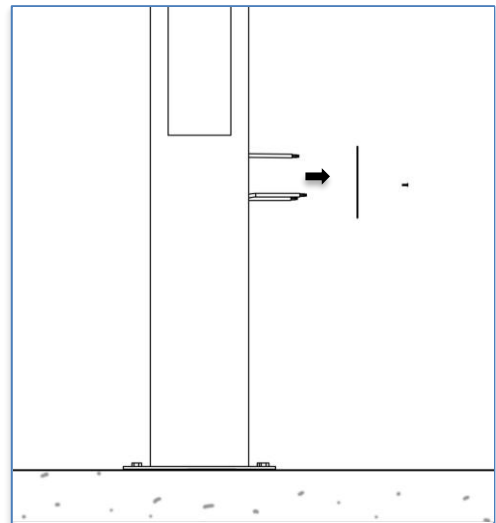
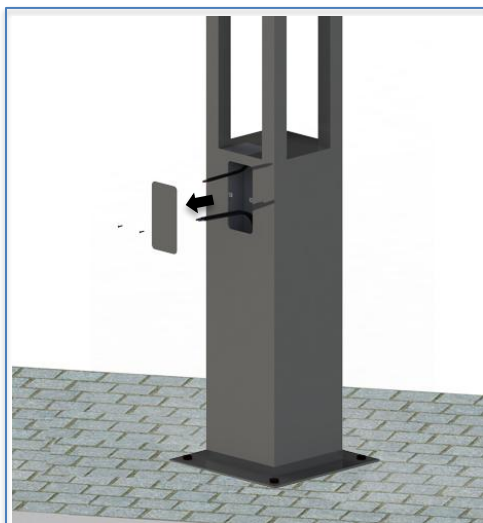



- **Step 4:** Keep all the connection inside the electrical compartment as illustrated. Please make sure the earth wire is reliable.

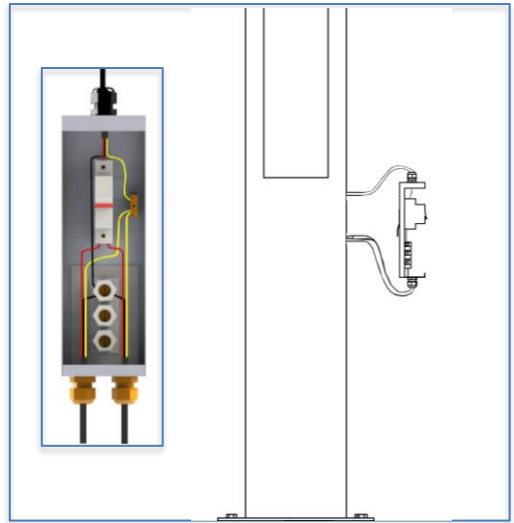

- **Step 5:** Close the cover of the electrical compartment. Keep the electrical compartment properly in its position.

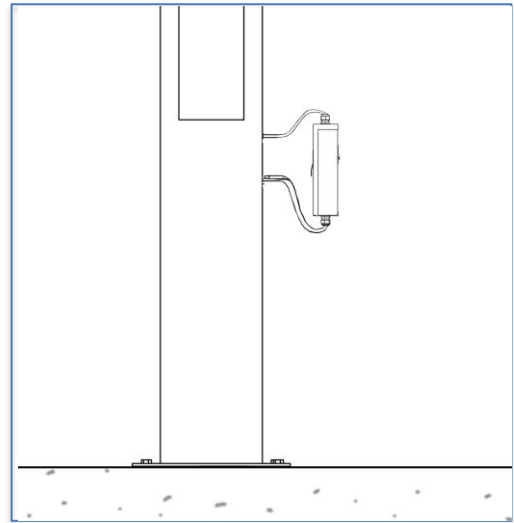

- **Step 6:** Close the electrical compartment access cover properly. .

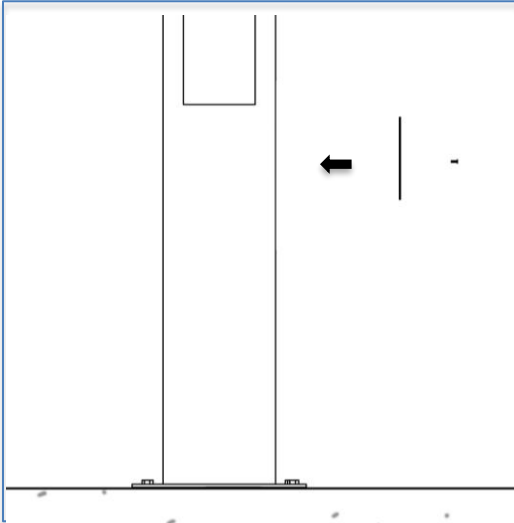

All the Installation and Maintenance must be done by Technicians and Professional Engineers

