

INSTALLATION INSTRUCTIONS

WL220377

Important Instructions. Please read first.

- Please follow instructions carefully. Failure to do so will void warranty. Please ensure installation complies with local law and applicable standards.
 1. Only use a GLP power supply unit.
 2. Ensure correct input voltage is connected to the luminaire.
 3. Ensure the power is disconnected before making any connections.
 4. Do not make modification or alter the luminaire without written approval of GLP.
 5. Ensure to keep luminaire in a clean area free of debris.



INSTALLATION

- **Step 1:** Find the location where the luminaire has to be installed. Install suitable wiring from the mains supply (180V-250VAC, 50/60Hz) to the luminaire.
- **Step 2:** Unscrew and Remove the front cover of the luminaire.

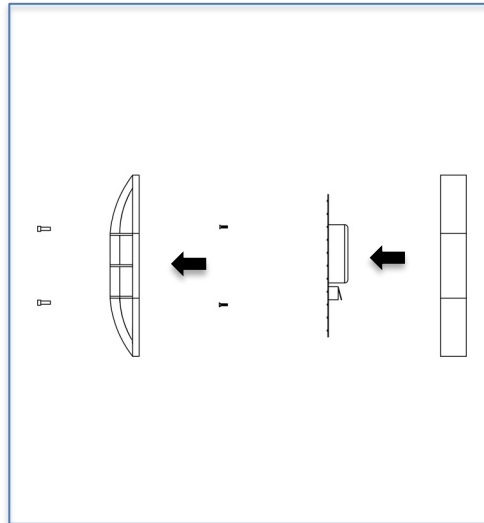

- **Step 3:** Mount the back body on to a hard surface using provided screws as illustrated.

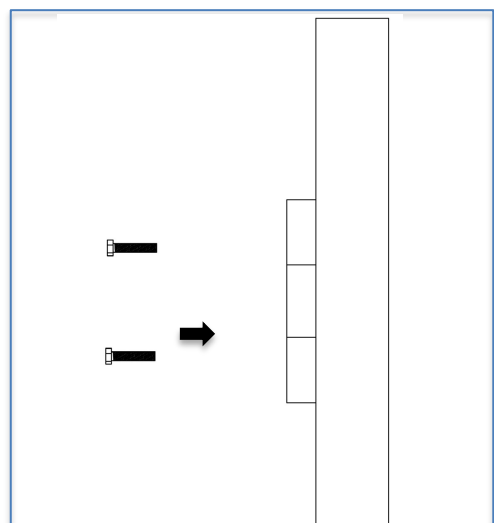
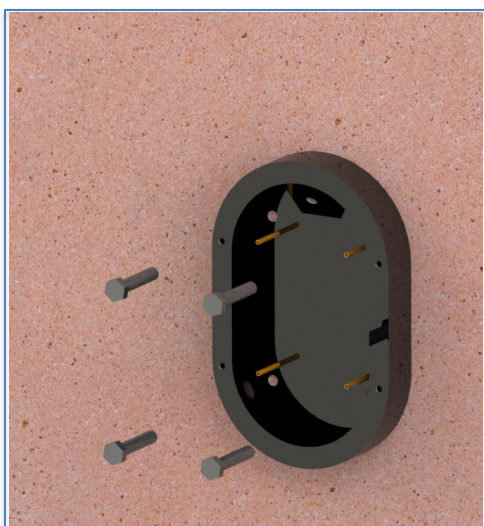

- **Step 4:** Connect the luminaire power cable to the main supply using terminal blocks or connectors as illustrated.

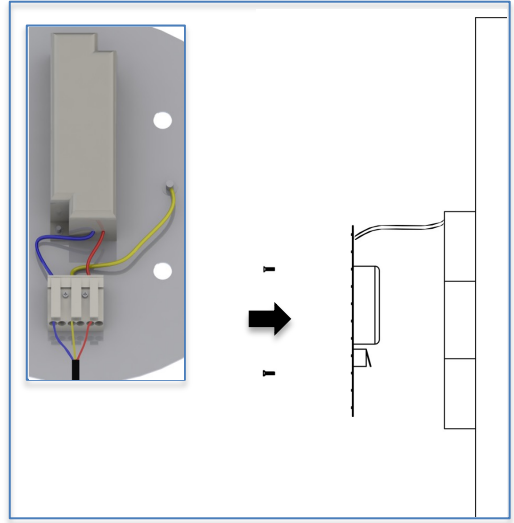
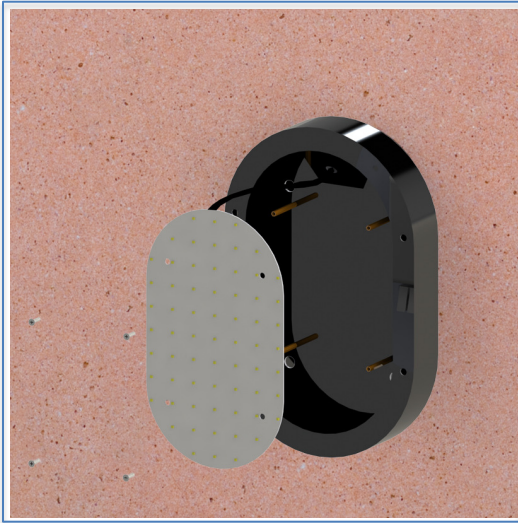

- **Step 3:** Reinstall the front cover back on to the luminaire as illustrated.

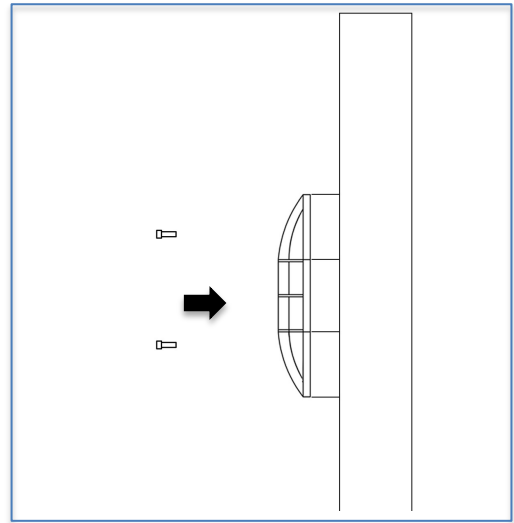
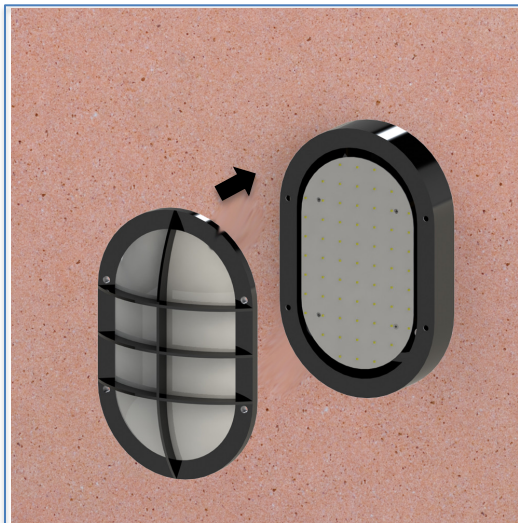

Make sure the main power is switched off during installation.

All the Installation and Maintenance must be done by Technicians and Professional Engineers

