

## INSTALLATION INSTRUCTIONS

WL220562

### Important Instructions. Please read first.

- Please follow instructions carefully. Failure to do so will void warranty. Please ensure installation complies with local law and applicable standards.
  1. Only use a GLP power supply unit.
  2. Ensure correct input voltage is connected to the luminaire.
  3. Ensure the power is disconnected before making any connections.
  4. Do not make modification or alter the luminaire without written approval of GLP.
  5. Ensure to keep luminaire in a clean area free of debris.



### INSTALLATION

- **Step 1:** Find the location where the luminaire has to be installed. Install a suitable wiring from the mains supply (180V-250V AC, 50/60Hz) to the luminaire.
- **Step 2:** Dig the mounting hole 20cm deeper before installing the Sleeve. Install the sleeve in the wall depending on type of tile thickness or concrete, raise the sleeve by 1- 2cm above the surface

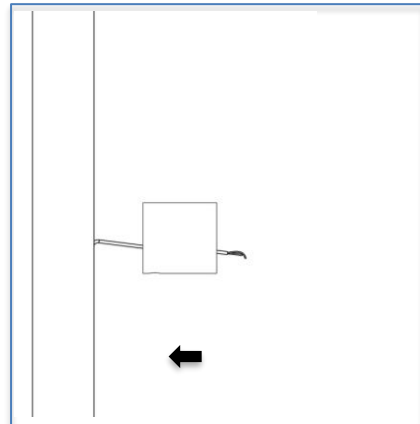
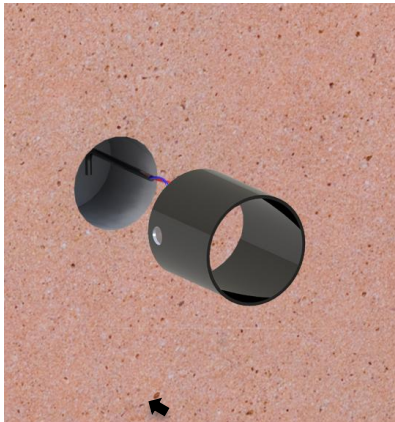

- **Step 3:** Connect the luminaire power cable to the main supply using terminal blocks or connectors. Wrap connectors or terminal blocks with electrical tape. Please make sure the earth (ground) wire is reliable.

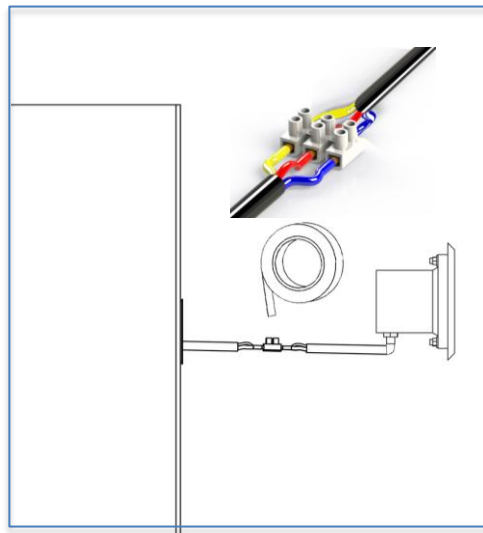

- **Step 4:** Fix the luminaire to the sleeve by press as illustrated.

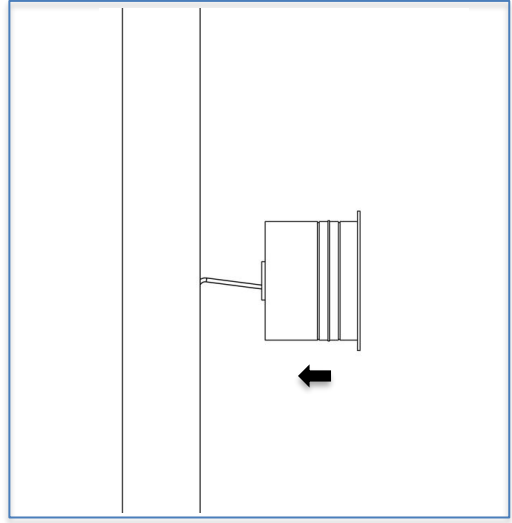

Make sure the main power is switched off during installation.