

INSTALLATION INSTRUCTIONS

4.5W SLIM PATH LIGHT – PL220042

Important Instructions. Please read first.

- Please follow instructions carefully. Failure to do so will void warranty. Please ensure installation complies with local law and applicable standards.
 1. Only use a GLP power supply unit.
 2. Ensure correct input voltage is connected to the luminaire.
 3. Ensure the power is disconnected before making any connections.
 4. Do not make modification or alter the luminaire without written approval of GLP.
 5. Ensure to keep luminaire in a clean area free of debris.



INSTALLATION

- **Step 1:** Find the location where the luminaire has to be installed. Install a suitable wiring from the power supply (12VAC) to the luminaire.
- **Step 2:** Mount the spike on the surface using a rubber mallet. Depending on type of surface raise the stake by 5cm above the surface as illustrated.

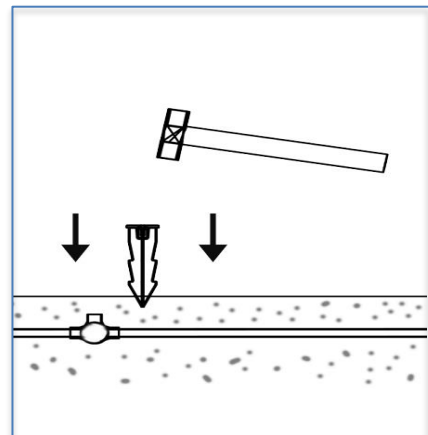
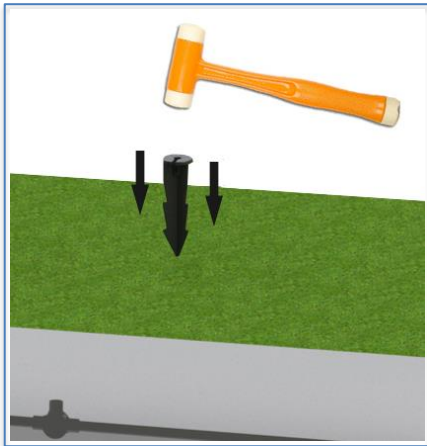

- **Step 3:** Fix the luminaire on the stake by rotating. Make sure the luminaire input cable is rotating with the luminaire to avoid potential damage to the input luminaire cable as illustrated.

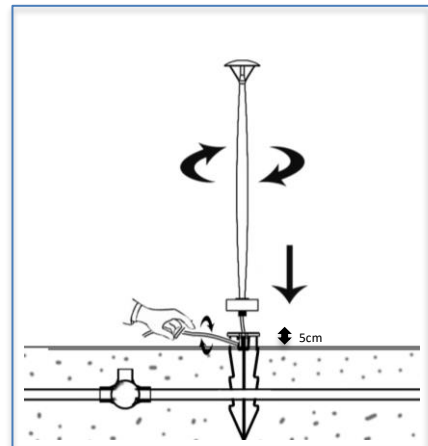
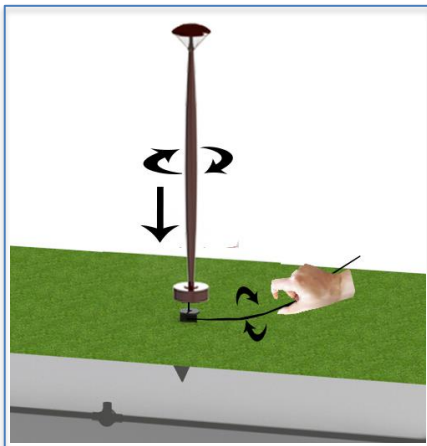

- **Step 4:** Connect the luminaire input cable to the main power supply (12V) cable (Do not cut the main power supply cable, just remove insulation, twist the luminaire input cable around the main cable). Ensure the junction box is installed within one meter from the luminaire as illustrated.

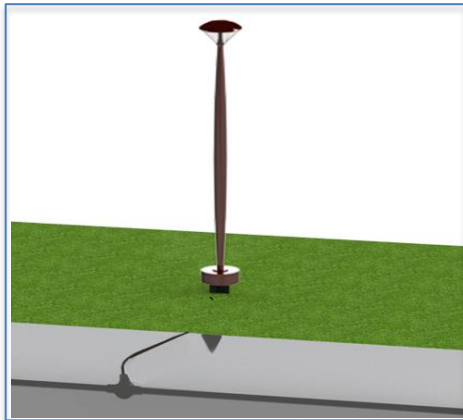

DO NOT CUT MAIN CABLE

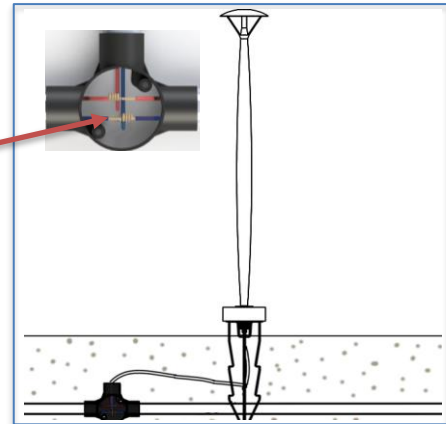

- **Step 5:** Solder the connections, wrap the connection with 3M waterproof tape & electrical tape and keep all the connections inside the junction box and put silicon on the top surface of the junction box and close the junction box with screws as illustrated.

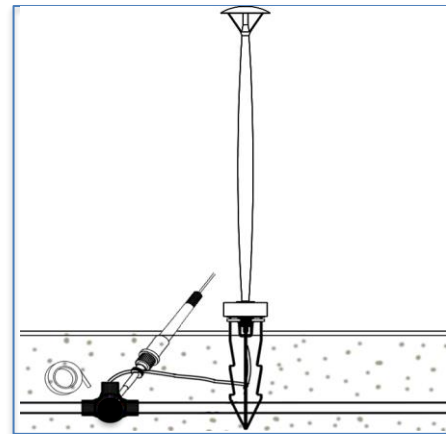
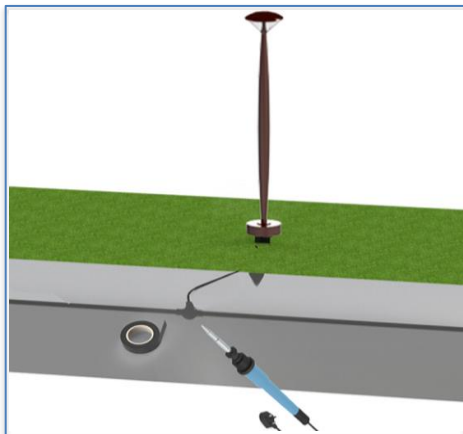

No. of fixtures	Wattage	Total Wattage	Wire Size
20 - 10	4.5W - 8.5W	80W	2.5mm ²
26 - 14	4.5W - 8.5W	110W	4mm ²
40 - 21	4.5W - 8.5W	170W	6mm ²
50 - 28	4.5W - 8.5W	230W	10mm ²



Make sure the main power is switched off during installation.

All the Installation and Maintenance must be done by Technicians and Professional Engineers