

INSTALLATION INSTRUCTIONS

6W BOLLARD LIGHT – BL220200

Important Instructions. Please read first.

- Please follow instructions carefully. Failure to do so will void warranty. Please ensure installation complies with local law and applicable standards.
 1. Only use a GLP power supply unit.
 2. Ensure correct input voltage is connected to the luminaire.
 3. Ensure the power is disconnected before making any connections.
 4. Do not make modification or alter the luminaire without written approval of GLP.
 5. Ensure to keep luminaire in a clean area free of debris.



INSTALLATION

- **Step 1:** Find the location where the luminaire has to be installed. Install a suitable wiring from the main supply (180-250V AC, 50/60Hz) to the luminaire.
- **Step 2:** Unscrew and remove the bottom plate of the luminaire as illustrated.

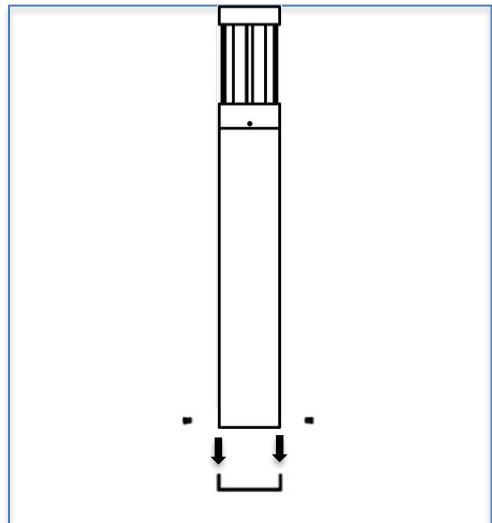

- **Step 3:** Mount the bottom plate of luminaire onto a hard surface using appropriate stainless steel screws as illustrated. Maintain foundation height 50mm above the ground for softscape installation.

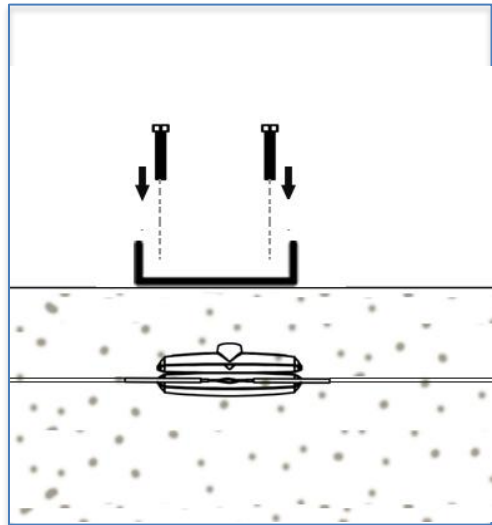
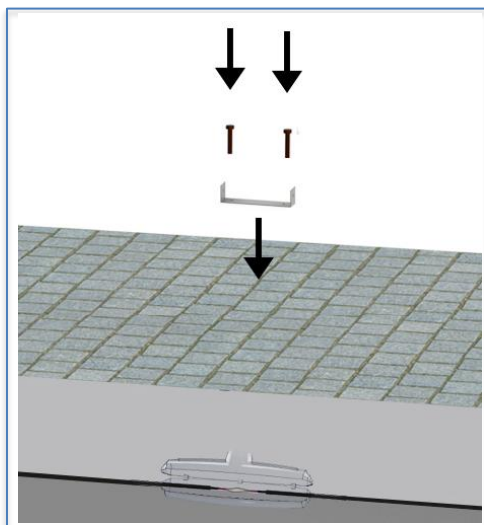

- **Step 4:** Connect the luminaire input cable to the main supply (180-250V AC, 50/60Hz) using a waterproof KIT. Ensure the waterproof KIT is installed with in 30cm from the luminaire as illustrated. Please make sure the earth (ground) wire is reliable.

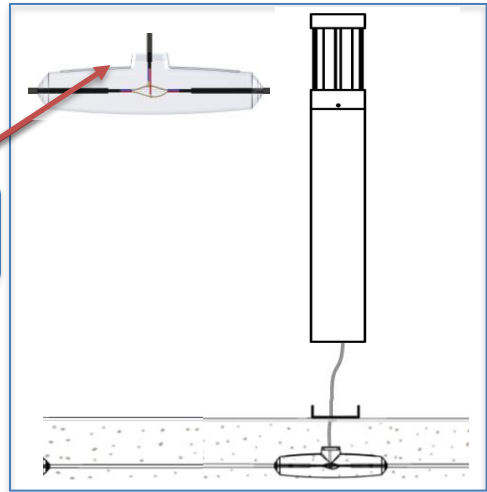
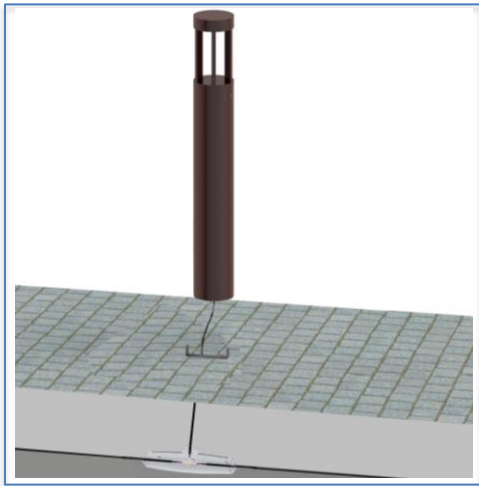

DO NOT CUT MAIN CABLE

- **Step 5:** Solder & Wrap the connections with 3M waterproof tape & electrical tape. Fill the M11 kit with epoxy as illustrated.

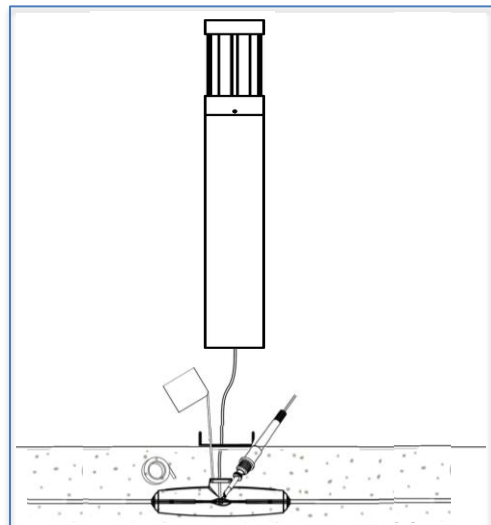
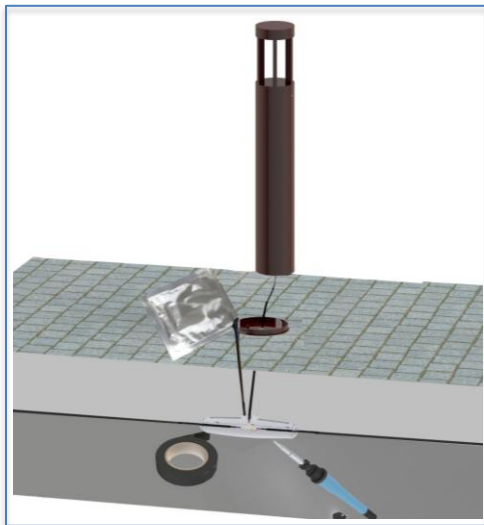

- **Step 6:** Install the luminaire body to the bottom plate of the luminaire as illustrated.

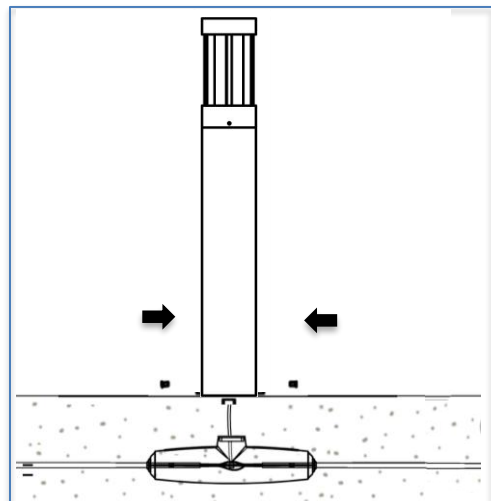
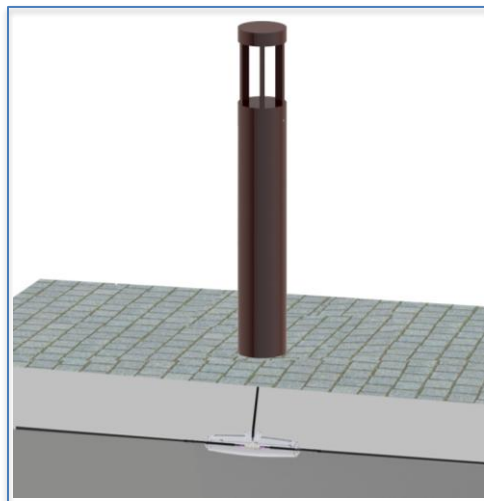

All the Installation and Maintenance must be done by Technicians and Professional Engineers